

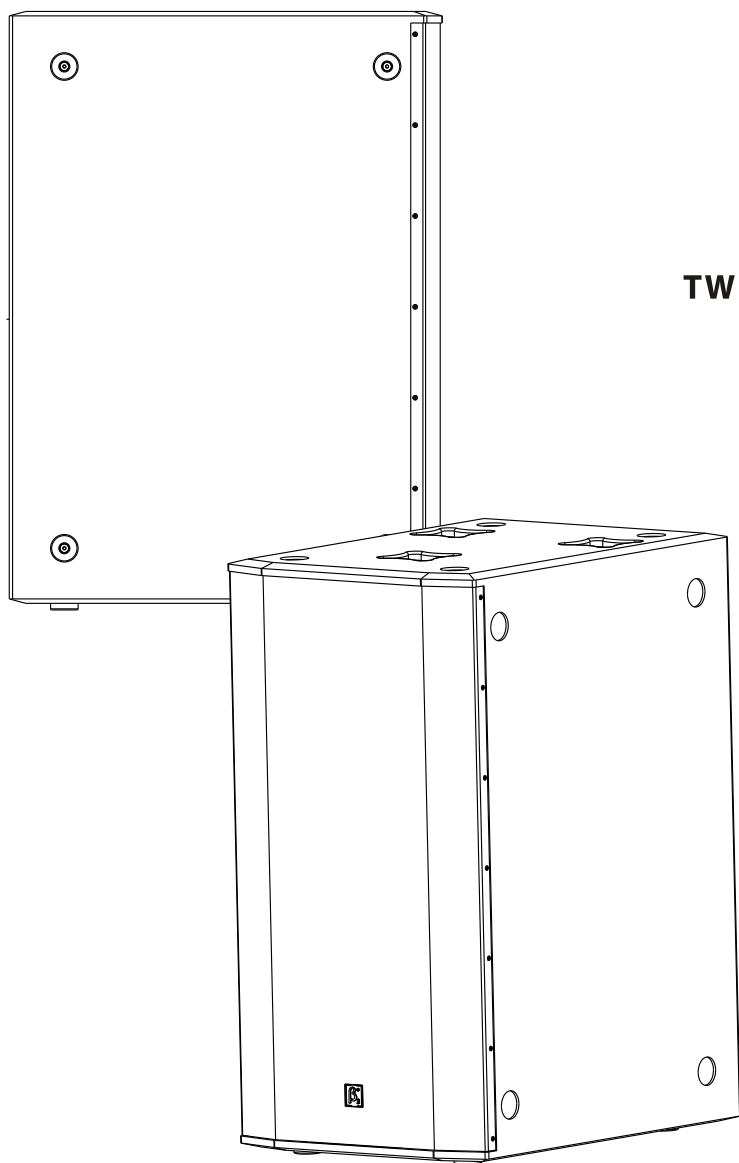

Beta Three



TW218Ba

Dual 18" Active Subwoofer

TW Series Pro Loudspeaker System

User Manual

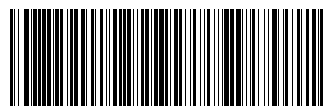





UM-TW218Ba-20160220 ver A



SAFETY INSTRUCTIONS

PLEASE READ THIS MANUAL FIRST

Thanks for buying β_3 products. Read this manual first as it will help you operate the system properly. Please keep this manual for future reference.

-  **WARNING:** This product must be installed by professionals. When using the hanging and rigging parts that are not appointed, please ensure the intensity of the structure comply with the local safety criterion.
-  **WARNING:** To reduce the risk of fire or electric shock, do not expose this apparatus to rain or moisture.
-  **WARNING:** To reduce the risk of electric shock, only qualified professionals can remove the cover of this system.

	CAUTION RISK OF ELECTRICAL SHOCK DO NOT OPEN	
CAUTION: TO REDUCE THE RISK OF ELECTRIC SHOCK, DO NOT REMOVE COVER (OR BACK). NO USER-SERVICABLE PARTS INSIDE. REFER SERVICING TO QUALIFIED PERSONNEL.		

	AVIS RISQUE DE CHOC ÉLECTRIQUE NE PAS OUVRIR	
ATTENTION : POUR RÉDUIRE LE RISQUE DE DÉCHARGE ÉLECTRIQUE, NE RETIREZ PAS LE COUVERCLE (OU L'ARRIÈRE). IL NE SE TROUVE À L'INTÉRIEUR AUCUNE PIÈCE POUVANT ÊTRE RÉPARÉE PAR L'USAGER. S'ADRESSER À UN RÉPARATEUR COMPÉTENT.		



The lightning flash & arrowhead symbol within an equilateral triangle is intended to alert you that this part is not dielectric, and may cause the hazard of electric shock.



The exclamation point within an equilateral triangle is intended to alert you to the presence of important operating and servicing instructions.



ATTENTION: This system must be connected to the output socket with grounded thread.



ATTENTION: Don't refit the system or spare parts without being authorized as this will cause the hidden trouble.



WARNING: Don't lay the fire source (such as lit candle) above the equipment.



ATTENTION: Please operate cautiously even when the main socket or the coupling apparatus is used as disconnection equipment.

1. Read this instruction first before using this product.
2. Please keep this manual for future reference
3. Pay attention to all warnings.
4. Obey all operating instructions.
5. Do not expose this product to rain or moisture.
6. Smear this equipment with dry cloth.
7. Do not block any ventilation openings. Install according to instructions of the manufacturer.
8. Do not install this product near any heat source, such as caliduct, heater, burner, or any other equipment with heat radiation (include amplifier).
9. Do not destroy the safety settings of the polarity or grounded connector. If the connector provided can't be plugged into the socket, please ask for the electrician to change the socket.
10. Avoid the thread (especially the connector, socket, and the parts outside the body) to be under kick or heavily hustled.
11. Only use spare parts appointed by manufacturer.
12. Please only use cart, stand, tripod, bracket and table that are appointed by manufacturer or sold together with the apparatus. Please avoid overturn the cart or apparatus when push.
13. In the event of lighting flash or nonuse for a long period, please put off the power supply and pull out the cord to avoid unexpected dangers.
14. When the apparatus damages in the case of the power cord or connector damages, liquids spill into the inside of the product or objects fall into, exposure to rain or moisture, apparatus are out of work or breaks, please ask for the help from the professionals.
15. To avoid hazard of fire or electric shock, please avoid socket, extend thread, and power supply been overloaded.
16. Take care that objects do not fall into and that liquids are not spilled into the inside of the product as this will cause hazard of fire or electric shock.
17. Pay attention to the safety symbol in the outer side of the cover.
18. Only plug the connector in proper power supply of which the voltage complies with this equipment. Please follow the operating instruction or symbol.
19. This equipment must be protected from the spill or insufflations of liquid. Do not lay objects filled with liquid (such as vase) above this equipment.



CONTENT

INTRODUCTION	3
Features	3
Description	3
Application	3
AMPLIFIER MODULE	4
Amplifier Module	4
INSTALLATION	5
Optional Accessories	5
Installation Reference	5
TECHNICAL SPECIFICATION	6
Technical Sheet	6
Frequency Response	6
2D Dimension	7

 Product information may be updated without notification, please visit www.elderaudio.com for latest update.

TW218Ba

Dual 18" Active Subwoofer

Features

- Light weight powered 2×18" subwoofer.
- 4500W continuous Class D power module.
- Strong punch penetrating with impact.
- Superior heat dissipation and protection system.
- Master volume, high cut, phase select, power / peak indication available.
- NEUTRIK PowerCon input and output power supply connector.
- Combine with any TW or T-series high power speaker for extended full range frequency, high quality music reproduction.

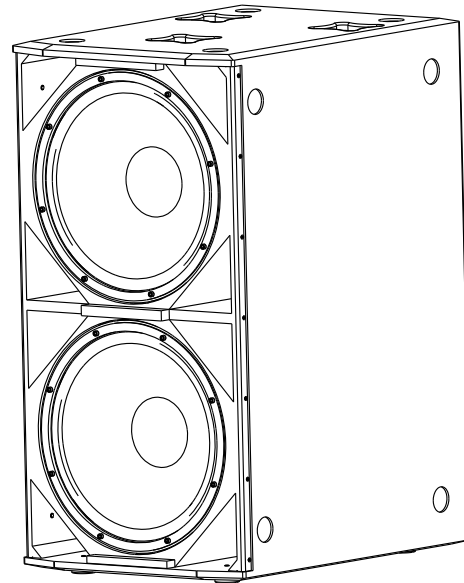

Description

β 3[®] TW218Ba active subwoofer utilizes high power low frequency drivers with structurally solid enclosures. The light weight Class D powered amplification module provides continuous 4500W power driving to ensure extended low frequency bandwidth with excellent punch. The switching power supply circuit design and favorable protection system allow long-time full loaded working condition.

Computer aided design to the structure, power coated protective grill, durable Polyurethane textured base paint make it hard core style among TW family. Suitable for Performing Arts, Auditoriums, Clubs, Houses of Worship, Entertainment Venues and Indoor Sports Facilities.

Applications

- Auditorium
- Small and medium performance
- Multifunctional hall
- Clubs and entertainment venues
- Indoor sports facilities

Amplifier Module

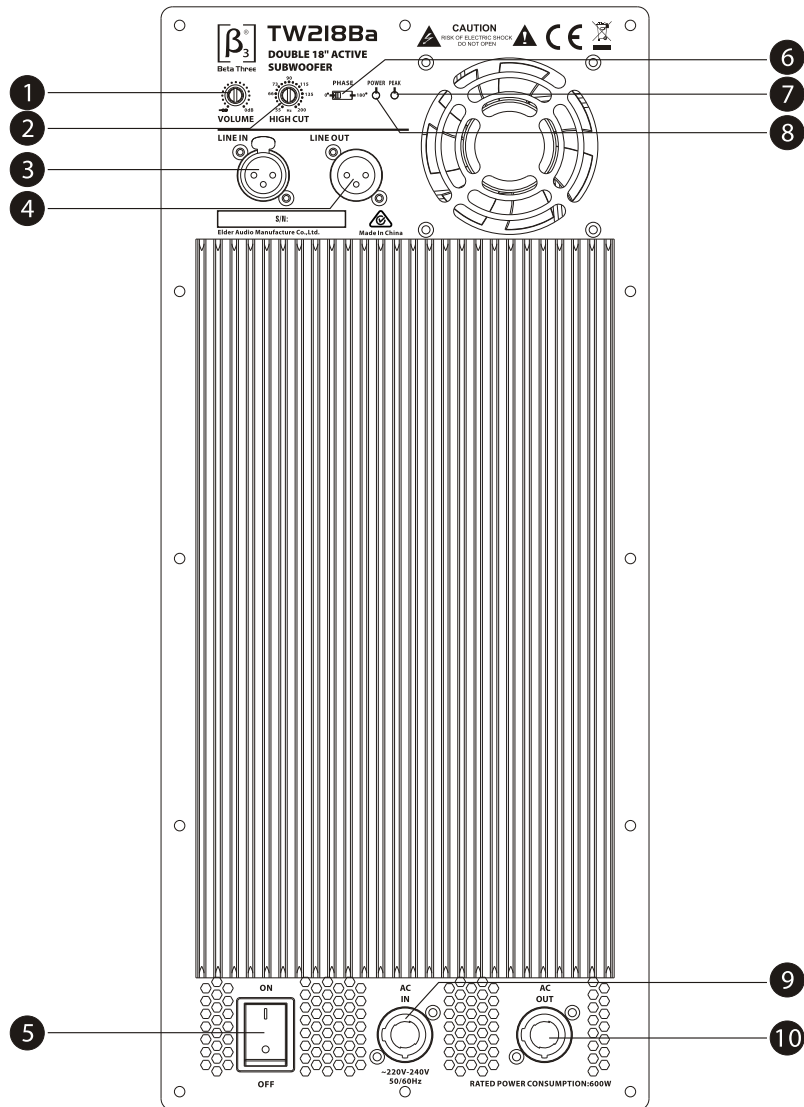

- | | |
|-------------------------------|--|
| 1. Volume control | 7. Overload indicator |
| 2. High cut control | 8. Power indicator |
| 3. Line input | 9. Power supply input. Make sure that the voltage is set for your country's correct voltage. |
| 4. Line output | 10. Power supply output |
| 5. Power ON/OFF switch | |
| 6. Phase selector switch | |

Optional Accessories

1. Mobile Caster

- Caster: $\phi 100 * 34\text{mm}$ 4pcs
- Screws: M8 *30 Hexagon 16pcs
- Spring washers: $\phi 8$ (Black) 16pcs
- Flat washers: $\phi 8$ (Black) 16pcs
- PE bag: 4pcs
- Carton: 1pc

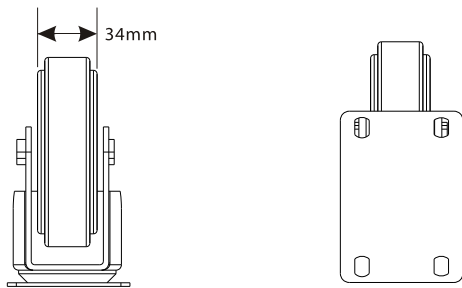
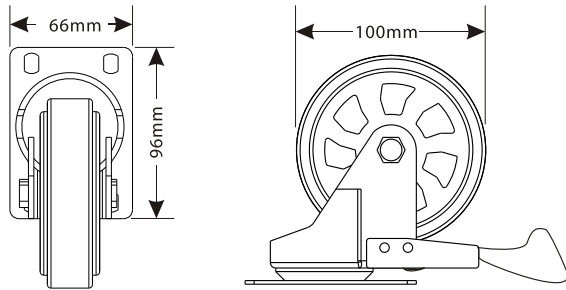

Installation Reference

1. Stack

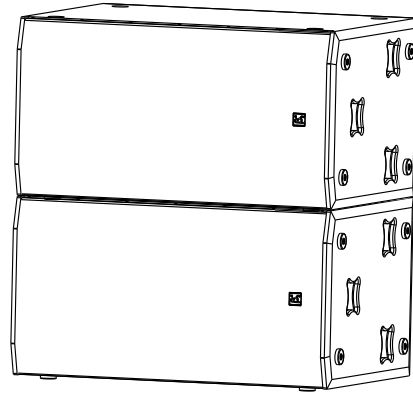

2. Transportation reference

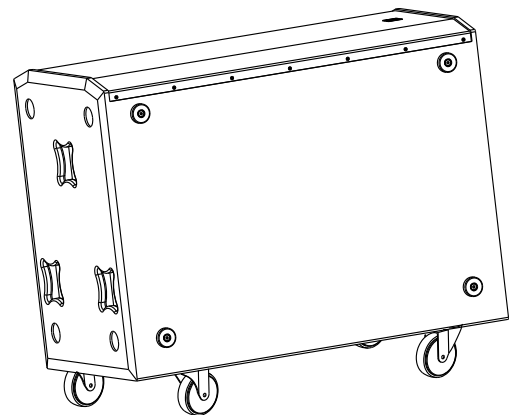

Warning: Make sure the mounting accessories safety factor not less than 5:1 or meet the local standard during installation .



Specification

Frequency response(-3dB):	40Hz-200Hz
Max.SPL:	132dB/138dB(PEAK)
Transducer:	2× 18" Woofer
Rated impedance:	4 Ohms
Connector:	XLR for input
Input:	Channel one (Mic/Line) balanced input
Input impedance(line):	20Kohm balanced input, 2Kohm unbalanced input
Input level:	0 dBV (0.775V rms, 1.0 V peak)Line-100Hz
Input overloading level:	Maximum input level 8 V peak
Wire connection:	pin 1: ground; pin2: signal +; pin3: signal -
Heat radiation:	Forced air-cooled drives
Power cable:	PowerCON power connector
Safety voltage range:	AC 220V-240V~50/60Hz
Amplifier power output:	4500W
Cabinet:	Plywood
Handle:	6× Wooden handles
Painting:	Powder coated grill
Cabinet dimension(W×D×H):	567×786×1075mm(22.3×30.9×42.3in)
Packing dimension(W×D×H):	1185×895×685mm(46.7×35.2×27.0in)
Net weight:	86.0kg(189.2 lbs)
Gross weight:	91.0kg(200.2 lbs)

Frequency response curve

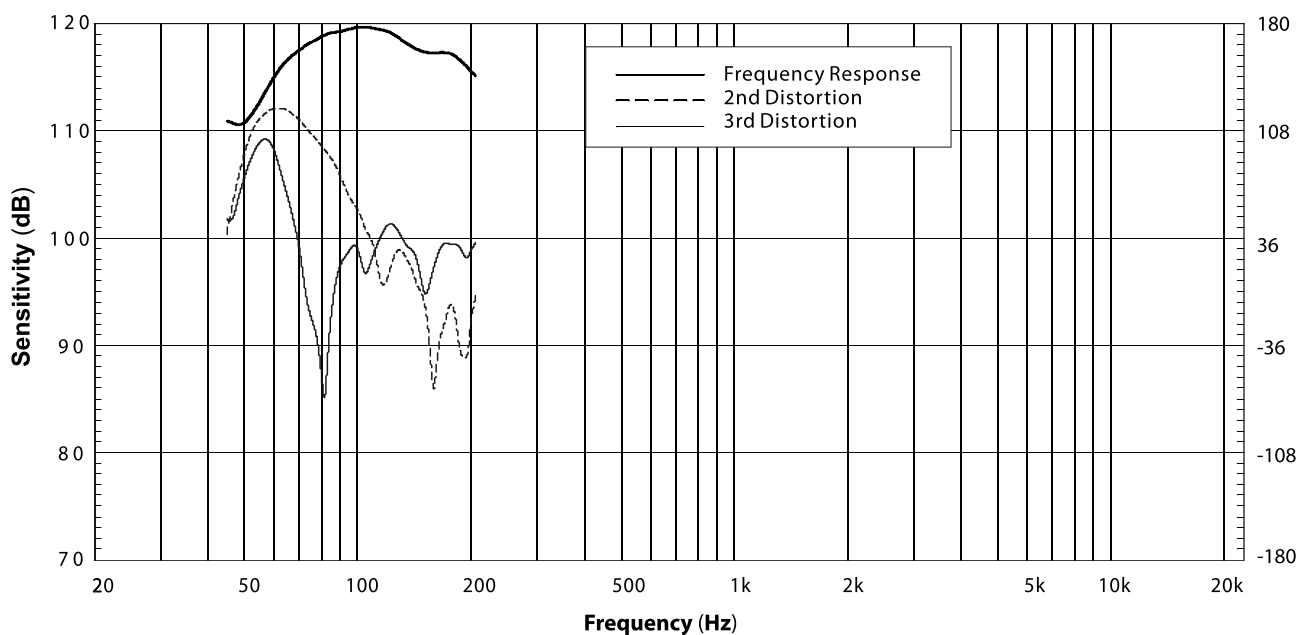

2D Dimension

Top view

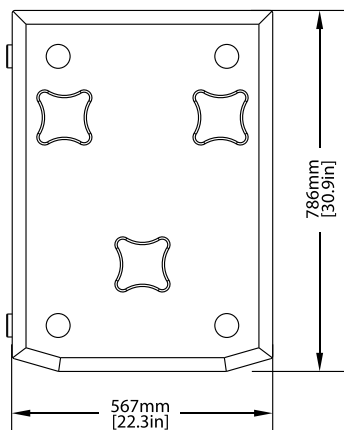

Side view

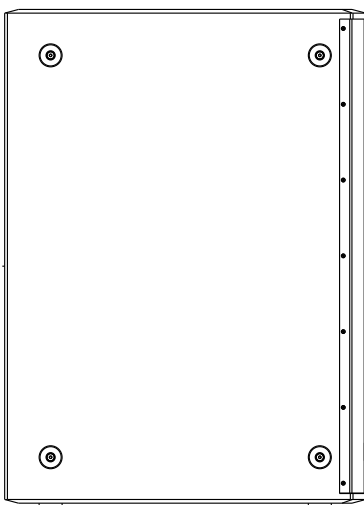

Front view

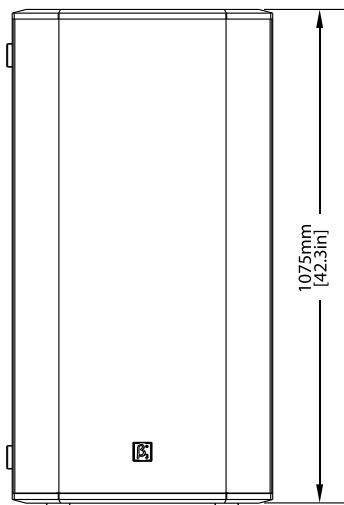

Back view

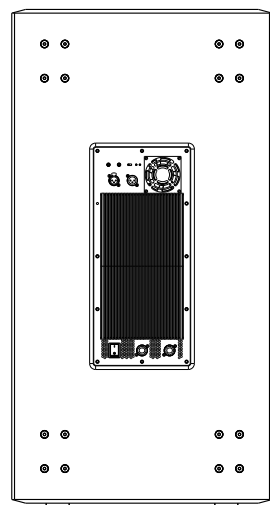

Bottom view

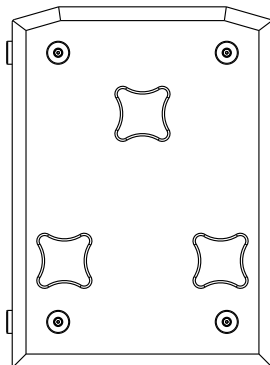

Notes:



Beta Three